

# IND813Z-RWTN

## 8 Megapixel Premium Series IP WDR Dome Camera with IR

Infinique offers a wide range of IP based high definition cameras available in various housing formats, including Box, Dome and Bullet. Our cameras are equipped with superior image sensor and digital signal processor to produce sharp, crisp pictures and are enclosed in weather and vandal resistant housings making it suitable for use in all security applications. The ONVIF compliance of the cameras helps in easy integration, providing peace of mind for your investment. From small to very large installations, Infinique's cameras are reliable, future proof and an ideal solution for your video surveillance needs.

The IND813Z-RWTN is a 8 Megapixel WDR IR Plastic Dome Camera with Motorized Zoom. Incorporating a 1/2.8" high quality image sensor and IR LEDs to provide clear crisp images both during day and night.

The camera comes equipped with a 2.8~12mm motorized zoom lens for easy setup of field of view. The auto iris control allows the camera to automatically set its iris position to maximize image quality in all lighting conditions. The camera streams real-time video at high definition resolution using H.264 or H.265 compression optimizing the bandwidth and increasing storage efficiency.

Built-in PoE for powering the camera and the flexible 3-axis bracket for fixing it on ceiling or wall, provides the convenience for installers to complete the installation quickly and with ease. These versatile cameras are suitable for video surveillance of government buildings, residential apartments, schools, colleges, universities, shopping malls, hospitals, hotels, industrial parks, and corporate offices.

### Product Features

- 1/2.8" Progressive Sensor
- 8 Megapixel Resolution at 25/30fps
- IR Distance up to 30 meters
- 2.8~12mm Motorized Zoom Lens with DC Auto Iris
- 130dB True WDR
- H.265 and H.264 Compressions
- Up to 3 Simultaneous Video Streams
- S/N Ratio of more than 50dB
- Micro SD Card Slot for Onboard Storage
- Two Way Audio, Alarm I/O
- Power Over Ethernet (PoE), IEEE 802.3af
- Vandal Proof Aluminum Alloy Housing
- Wall or Ceiling Mount with 3 Axis Bracket
- ONVIF Compliant



### Dimensions

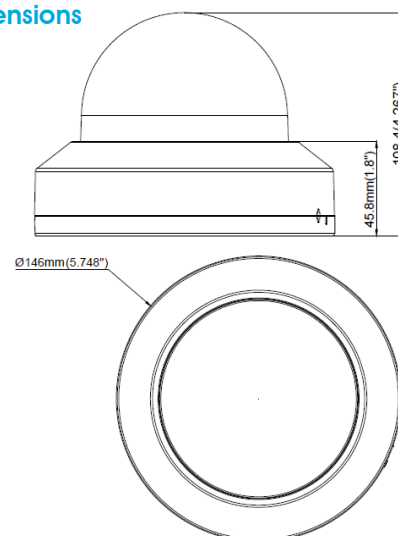

### Accessories



Part No: IJBDWM-146  
Wall Mount Junction Box



Part No: IBDLWM-2  
Indoor Wall Mount L Bracket



Part No: IJBBCM-146  
Ceiling Mount Junction Box



Part No: IBDCFM-2  
Ceiling Flush Mount Bracket



Part No: IBKTCM  
Pendant Ceiling Bracket



Part No: IBBCPM  
Pole Mount Bracket



Part No: IBCRWM  
Corner Mount Bracket

# IND813Z-RWTN

## 8 Megapixel Premium Series IP WDR Dome Camera with IR



IMAGE PERFORMANCE	
Image Sensor	1/2.8" Progressive Sensor
Effective Pixels (H x V)	3840 (H) x 2160 (V)
Resolution (Megapixels)	8
Minimum Illumination	0.05 lux (AGC ON) 0 lux with IR ON
Image Rate (FPS)	25/30, adjustable for all resolutions
S/N Ratio	More than 50dB
IR Distance (m)	30
LENS	
Focal Length (mm)	2.8~12 Motorized Zoom Lens
Iris	DC Auto Iris
Lens Mount	M14
Aperture Ratio	F1.2
Angle of View (deg)	H:108.6°(Wide)~22.4°(Tele), V:81.4°(Wide)~15.8°(Tele)
VIDEO	
Video Compression	H.265 Main Profile H.264 Baseline Profile/Main Profile/High Profile
Main Stream	3840 x 2160, 2592 x 1944, 2592 x 1520, 2048 x 1520, 1920 x 1080, 1280 x 720
Sub Stream	1920 x 1080, 1280 x 720, 640 x 480, 320 x 240
Mobile Stream	640 x 480, 320 x 240
Electronic Shutter Control	Auto, 1/8 ~ 1/20,000
Day/Night Control	True Day/Night with IR Cut Filter
Flicker Control	50 Hz, 60 Hz
WDR Type	True WDR, 130dB Variable Coefficient
3D Noise Reduction	Auto / Manual / Disable
White Balance	Automatic / Manual
Back Light Compensation	On / Off
Automatic Gain Control	Auto/Manual, Adjustable Level
Privacy Mask Zones	Up to 4 Privacy Mask Zones
Alarm IO	1x Input, 1x Output
Audio Input/ Output	Line level input and output, 3.5mm AV Interface
Video Bit rate	256K-16M ,Supports CBR/VBR
OSD	Camera ID, Timestamp
Image Orientation	Image Flip, Corridor Mode, Rotation
Image Controls	Brightness, Contrast, Hue, Saturation, Sharpness
Advanced Functions	Image Rotation, Gain Control, Anti-Fog, Anti-False Color, Anti-Shake, IR Detection, Motion Detection
VIDEO ANALYTICS	
Motion Detection	Multiple Zones
Advance Video Analytics	Tamper, Out Of Focus, Sound, Perimeter Intrusion, Line Crossing, Stationary Object, Pedestrian Detection,

LOCAL STORAGE	
Storage Type	Micro SD Card, Max up to 256GB
Recording	Video and Image; Auto / Schedule/ Manual / On Event
NETWORK	
Network Port	10/100M BASE-TX, RJ-45 Connector
Cabling Type	Category 6 and higher
Network Protocol	IPv4, HTTP, HTTPS, TCP/IP, Unicast/Multicast, UDP, RTP, RTSP, RTCP, DNS, DDNS, DHCP, FTP, NTP, PPPOE, SMTP, SNMP, UPNP, IEEE802.1X
ONVIF Protocol	ONVIF Compliant
Security	User Access with password protection, IP Filtering
Users	1 Administrator, 6 Users
Simultaneous Viewing	Up to 5 users
PC Web Browser	IE 6.0 Above; Mozilla Firefox; Google Chrome
Mobile Device	iOS, Android
Events	Motion, Tamper Detection, Sensor, Network Failure
Event Handlers	FTP, E-mail, Local Storage
MECHANICAL	
Housing ID	V4DIPWH660730S1
Dimensions (mm)	146 (D) x 108 (H)
Weight (g)	510
Housing	ABS Plastic
Finish	White, RAL 9003
Installation	Ceiling Mount / Wall Mount, 3-Axis Bracket
ELECTRICAL	
Power Consumption	440mA, 12V DC, 5.28 W
Power Source	PoE IEEE802.3af; DC12V; AC 24
Power Connector	DC Male Plug
RTC Backup Battery	3V Magnesium Lithium
ENVIRONMENTAL	
Operating Temperature (C)	-20 to +50
Storage Temperature (C)	-20 to +60
Operating Humidity	0% - 95% non condensing
Ingress Protection Rating	IP66
IK Rating	IK07
STANDARDS COMPLIANCE	
Emissions	FCC Part 15 Subpart B Class B EN 55022:2010 IC ICES-003 Class B
Immunity	EN 55024:2010
Safety	UL 609501, EU: 2001/95/EC GPSPD











ORDERING INFORMATION	
PART NUMBER	DESCRIPTION
IND813Z-RWTN	Infinique Premium Series Indoor WDR IR Dome Camera, 8MP, 2.8-12mm Motorized Zoom Lens, IR Array LED, 30m IR Range, H.265, H.264, Three Video Streams, 130dB WDR, True Day and Night with ICR, Adjustable Bit Rate, SDHC Slot, ONVIF Compliant, PoE, IP66, IK07
IJBDWM-146	Infinique Wall Mount Junction Box, Base Diameter 146 mm
IBDLWM-2	Infinique Indoor Wall Mount L Bracket
IJBBCM-146	Infinique Ceiling Mount Junction Box, Base Diameter 146 mm
IBDCFM-2	Infinique Ceiling Flush Mount Bracket, Hole Diameter 190 mm
IBKTCM	Infinique Pendant Mount Ceiling Bracket, 45 (D) x 294 (H) mm
IBBCPM	Infinique Pole Mount Bracket with Metal Ties, 125 (L) x 46 (W) x 200 (H) mm
IBCRWM	Infinique Corner Mount Bracket, 200 (L) x 130 (W) x 172.8 (D) mm

# IND813Z-RWTN

8 Megapixel Premium Series IP WDR Dome Camera with IR



## Housing Accessories

<p><b>WALL MOUNT APPLICATION</b></p>  <p>Junction Box IJDWM-146</p>	<p><b>CEILING MOUNT APPLICATION</b></p>  <p>Junction Box IJBBCM-146</p>	<p><b>WALL MOUNT APPLICATION</b></p>  <p>L Bracket IBDLWM-2</p>	<p><b>PENDANT MOUNT APPLICATION</b></p>  <p>Ceiling Bracket IBKTCM</p>
<p><b>FLUSH MOUNT APPLICATION</b></p>  <p>Ceiling Bracket IBDCFM-2</p>	<p><b>POLE MOUNT APPLICATION</b></p>  <p>Pole Bracket IBBCPM</p>  <p>Junction Box IJDWM-146</p>		 <p>Junction Box IJBBCM-146</p>
<p><b>CORNER MOUNT APPLICATION</b></p>  <p>Corner Bracket IBCRWM</p>  <p>L Bracket IBDLWM-2</p>			



Infinique, a Canadian company is a manufacturer of high performing end-to-end solutions in copper, fiber and video surveillance systems. For more information visit our website at [www.infinique.com](http://www.infinique.com) or email us at [sales@infinique.com](mailto:sales@infinique.com).